

Kit 3049

MERCEDES C-Class (W204), 4-dr Sedan, 04- / *07-
MERCEDES E-Class (C207), 2-dr Coupé, 09- / *10-
MERCEDES E-Class (W212), 4-dr Sedan, 09- / *10-
MERCEDES CLS, 4-dr Coupé, 10-

*North America

This Kit is only for vehicles with fixpoint and without glassroof.

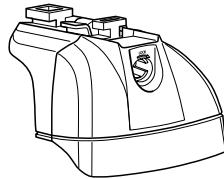

460R
753

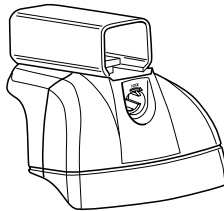
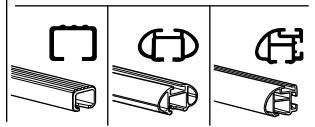

460

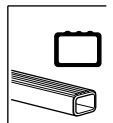

Kit

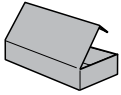

753

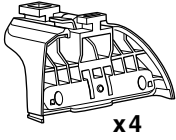

x4



x4



x4



x8

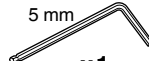

x1



x4



x1

460R

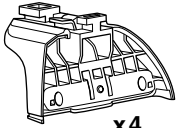

x4



x4



x4



x8

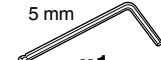

x1



x4

460

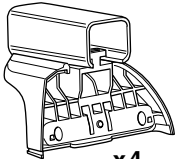

x4



x4



x4



x8

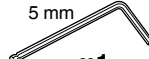

x1



x4

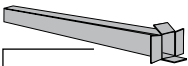

x2



x1

17 mm



x2

23 mm



x2

23 mm



x2



x2

17 mm



x2

23 mm

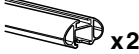

x2

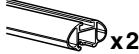

x2

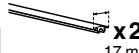

x2

25 mm

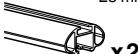

x2



x4

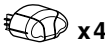

x4



x4



x2

x2

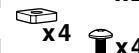

x4

x4



x1

5 mm

1

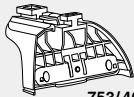

753/460R

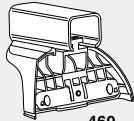

460

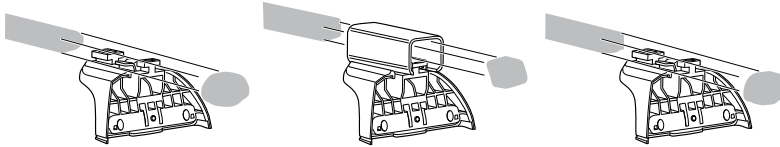

x4

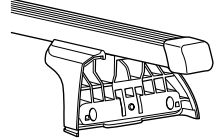
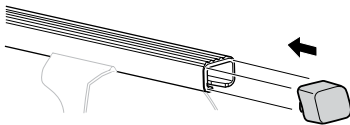

x4

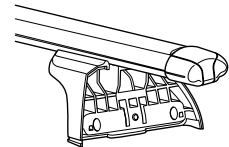
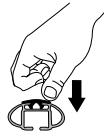
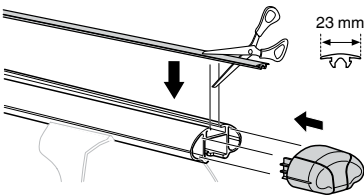

x4

x4

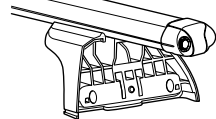
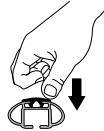
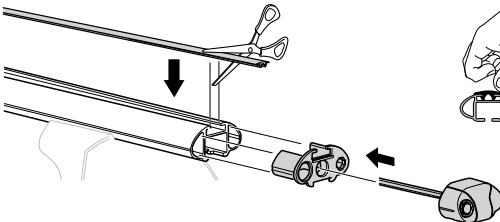

x4

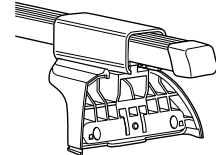
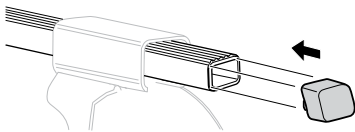

x2

x2

x4

x4

x1
5 mm

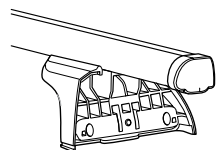
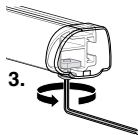
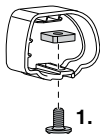
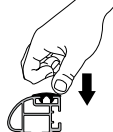
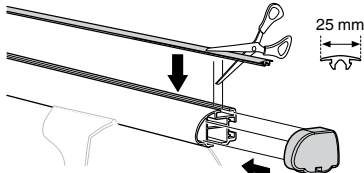

2

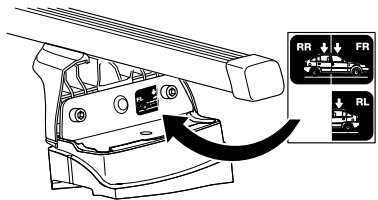
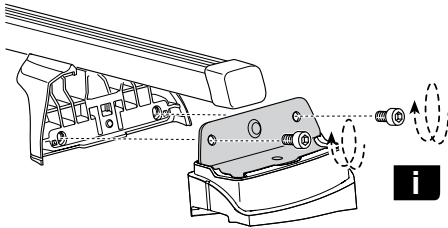
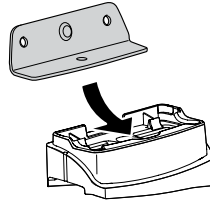
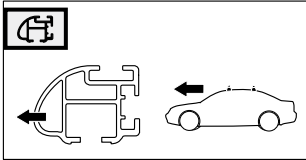
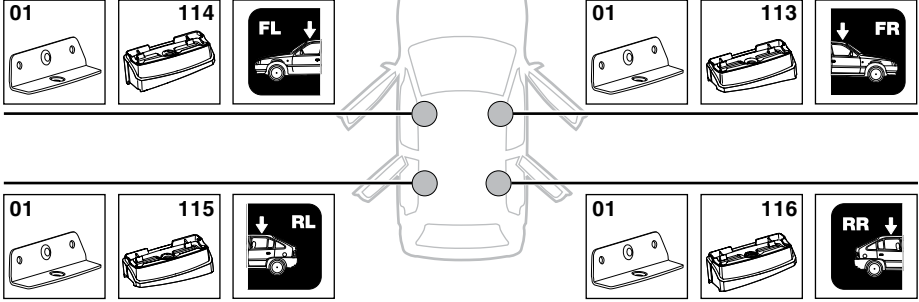
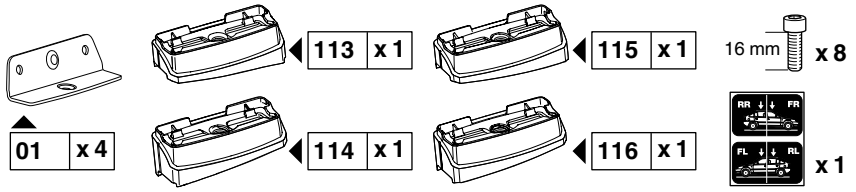

| | | | |
|----------|------------------------------------|--|------------------------------------|
| i | GB Only a few turns | EST Ainult mõni pööre | HR Samo nekoliko okreta |
| | D Nur wenige Umdrehungen | LAT Tikai dažī apgriezieni | HU Csak néhány fordítás |
| | F Quelques tours uniquement | LIT Tik keli pasukimai | GR Μόνο μερικές στροφές |
| | NL Slechts enkele slagen | PL Wystarczy kilka obrotów | TR Yalnız birkaç kez çevirm |
| | I Solo qualche giro | RU Достаточно нескольких оборотов | 中文 只有几个转向 |
| | E Sólo algunas vueltas | | 한국어 두 세번만 |
| | PT Noções básicas | CZ Pouze několik otáček | 日本語 数回転のみ |
| | S Endast några varv | SK Len niekoľko otáčok | ไทย หมุนเพียงไม่กี่รอบ |
| | FIN Vain muutama kierros | SLO Le nekaj obratov | |

3



x4



x4



x4

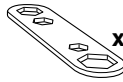

x1

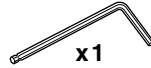

x1

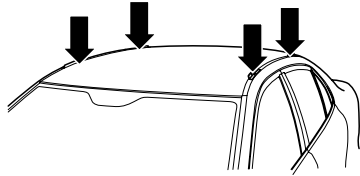

A

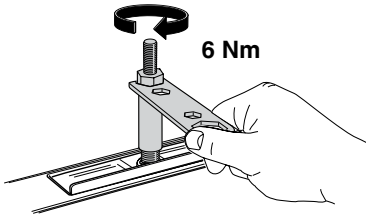
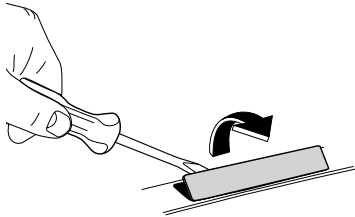

B

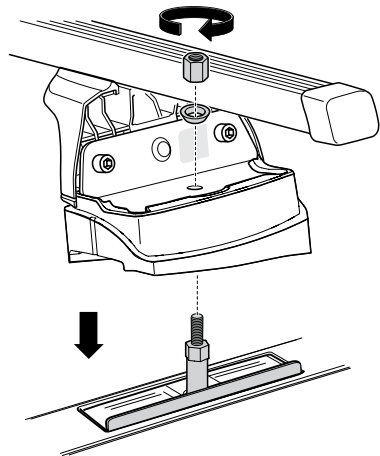

C

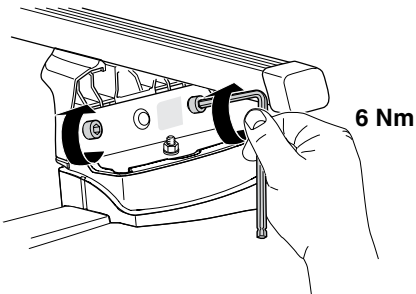

D

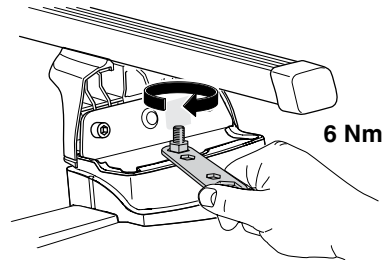

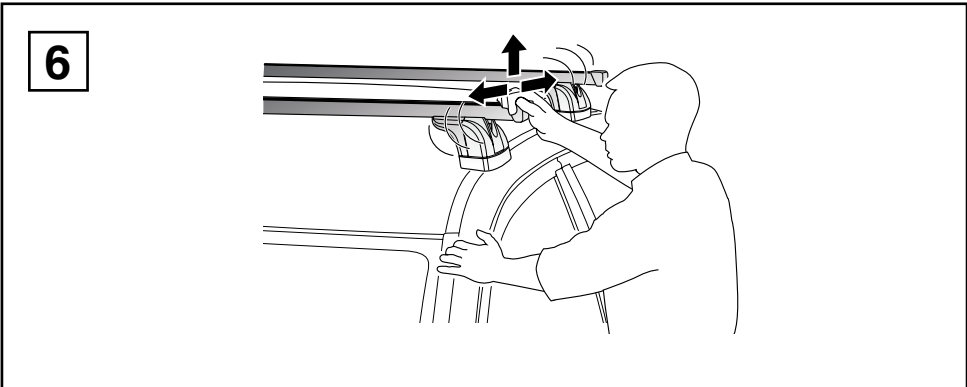
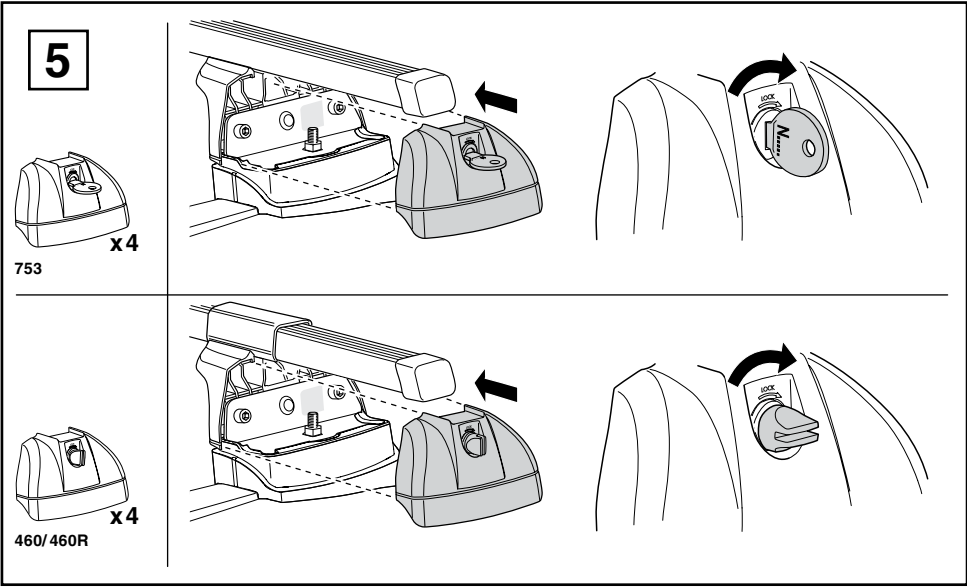
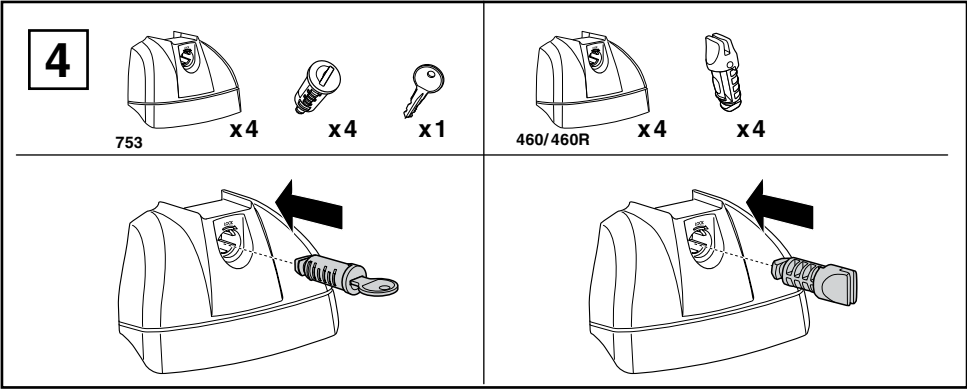

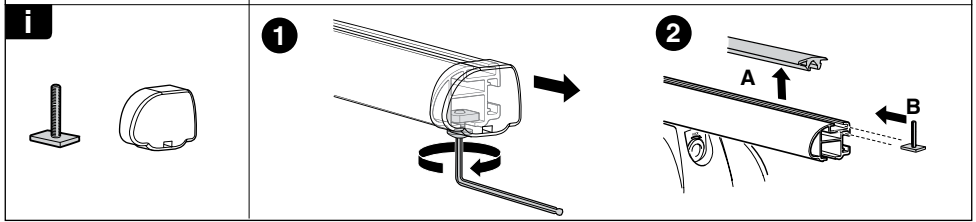
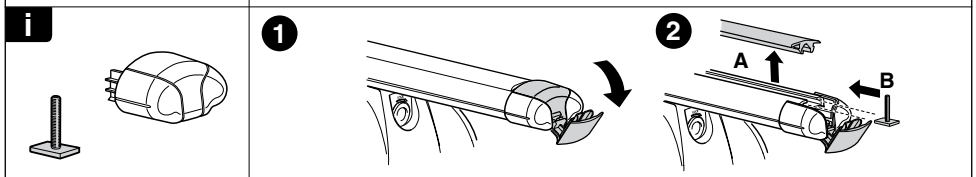
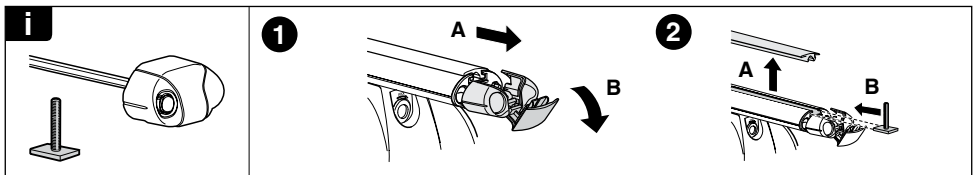
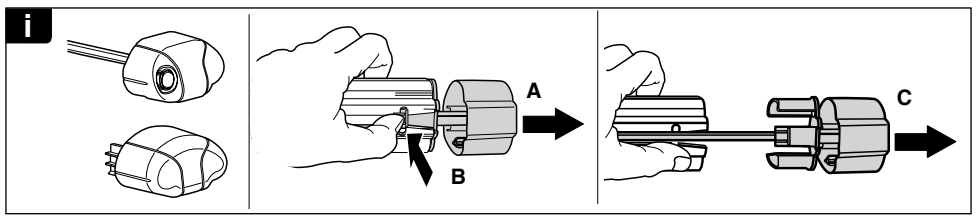
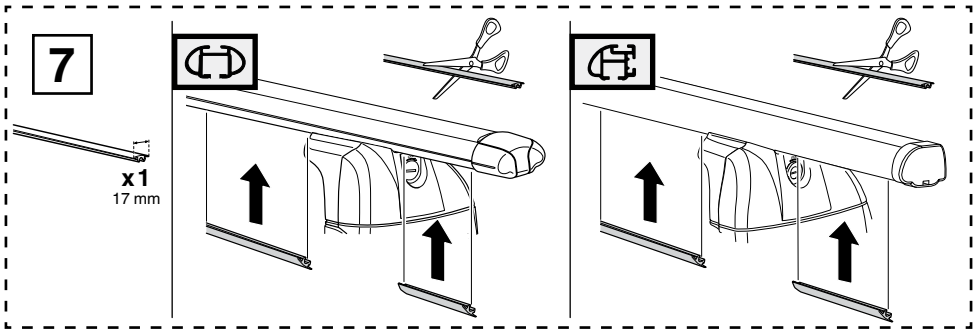

THULE
SWEDEN

**ONE
KEY
SYSTEM**

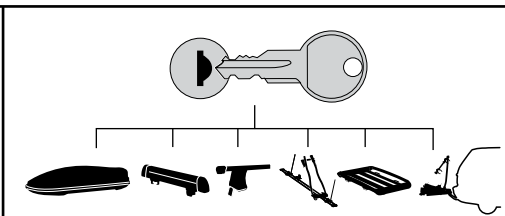

- 544 (x4)
- 596 (x6)
- 588 (x8)
- 510 (x10)
- 510 (x10)
- 452 (x12)